

SAGAR AUTOMOBILES

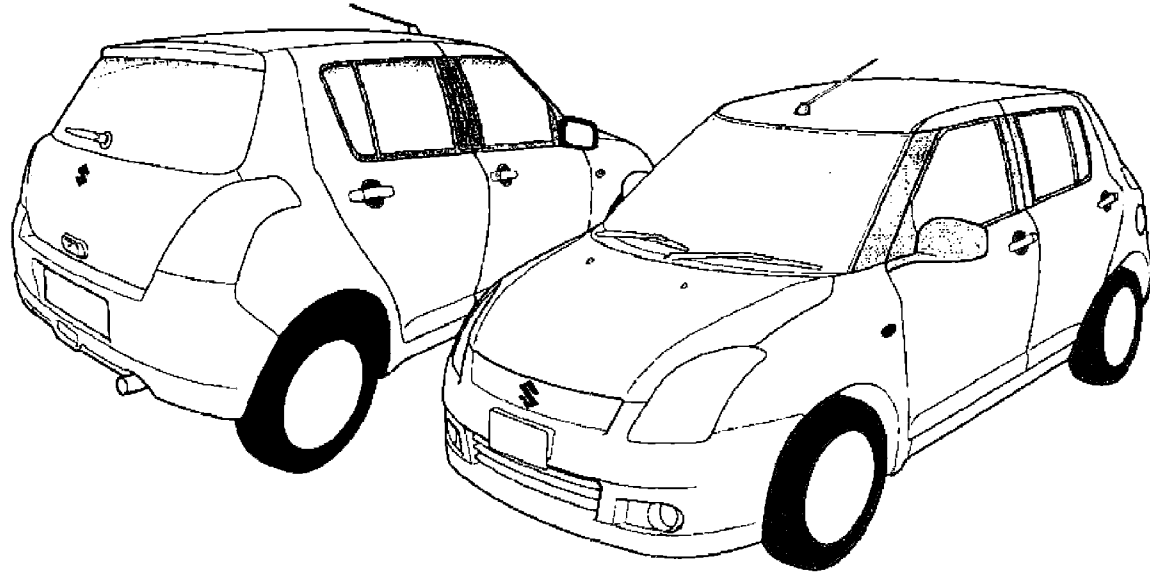

# SWIFT

OWNER'S MANUAL

# TABLE OF CONTENTS

<b>INSTRUMENT PANEL</b>	<b>3</b>
<b>OTHER CONTROLS AND EQUIPMENT</b>	<b>4</b>
<b>OPERATING YOUR VEHICLE</b>	<b>5</b>
<b>DRIVING TIPS</b>	<b>6</b>
<b>VEHICLE LOADING AND TOWING</b>	<b>7</b>
<b>INSPECTION AND MAINTENANCE</b>	<b>8</b>
<b>EMERGENCY SERVICE</b>	<b>9</b>
<b>BODY WORK CARE</b>	<b>10</b>

**INSTRUMENT PANEL**

**Instrument Panel ..... 3-1**

**Instrument Cluster ..... 3-2**

**Warning and Indicator Lights ..... 3-3**

**Speedometer/Odometer/Trip meter ..... 3-7**

**Tachometer (if equipped) ..... 3-8**

**Fuel Gauge ..... 3-9**

**Temperature Gauge ..... 3-9**

**Hazard Warning Switch ..... 3-9**

**Heated Rear Window Switch (if equipped) ..... 3-10**

**Headlight Leveling Switch (if equipped) ..... 3-10**

**Front Fog Light Switch (if equipped) ..... 3-11**

**Glove Box ..... 3-11**

**Heating and Air Conditioning System ..... 3-12**

**Manual Heating and Air Conditioning System ..... 3-13**

**Automatic Heating and Air Conditioning System  
(Climate Control) ..... 3-16**

SAGAR AUTOMOBILES

**Instrument Cluster**

with tachometer

1. Speedometer
2. Odometer/Trip meter
3. Odometer/Trip meter selector knob
4. Tachometer (if equipped)
5. Fuel gauge
6. Temperature gauge
7. Warning and indicator lights

**EXAMPLE**

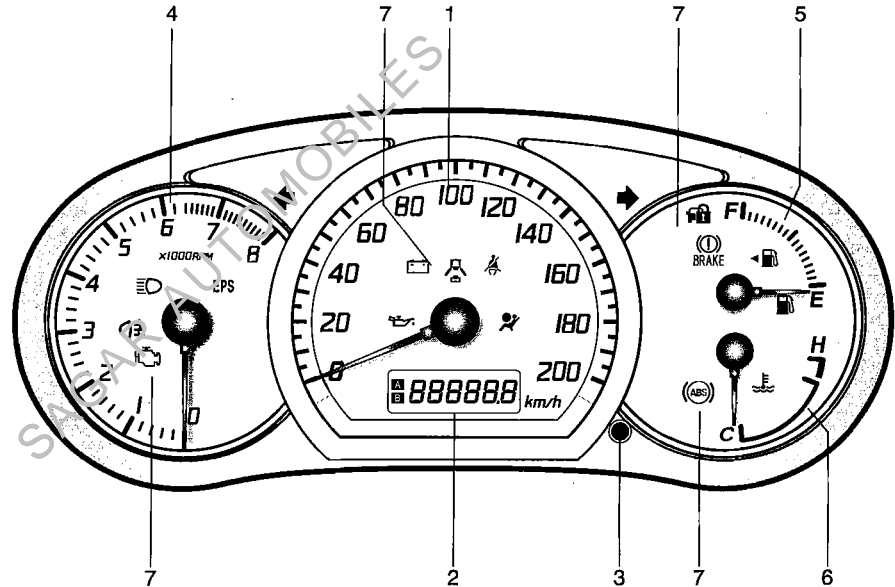

If the brake system warning light comes on while you are driving the vehicle, it may mean that there is something wrong with the vehicle's brake system. If this happens, you should:

- 1) Pull off the road and stop carefully.

## ▲ WARNING

**Remember that stopping distance may be longer, you may have to push harder on the pedal, and the pedal may go down farther than normal.**

- 2) Test the brakes by carefully starting and stopping at the side of the road.
  - If you determine that it is safe, drive carefully at low speed to the nearest dealer for repairs, or
  - Have the vehicle towed to the nearest dealer for repairs.

## ▲ WARNING

**If any of the following conditions occur, you should immediately ask your MARUTI dealer to inspect the brake system.**

- If the brake system warning light does not go out after the engine has been started and the parking brake has been fully released.
- If the brake system warning light does not come on when the ignition switch is turned to the "ON" or "START" position.
- If the brake system warning light comes on at any time during vehicle operation.

### NOTE:

*Because the disc brake system is self-adjusting, the fluid level will drop as the brake pads become worn. Replenishing the brake fluid reservoir is considered normal periodic maintenance.*

## Anti-Lock Brake System (ABS) Warning Light (if equipped)

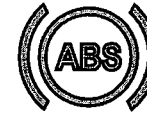

65D529

When the ignition switch is turned to the "ON" position, the light comes on briefly so you can check that the light is working. If the light stays on, or comes on when driving, there may be something wrong with the ABS.

If this happens:

- 1) Pull off the road and stop carefully.
- 2) Turn the ignition switch to "LOCK" and then start the engine again.

If the warning light comes on briefly then turns off, the system is normal. If the warning light still stays on, the system will be something wrong.

If the light and the brake system warning light stay on, or come on simultaneously when driving, your ABS system is equipped with the rear brake force control function (Proportioning valve function) and there may be something wrong with both the rear brake force control function and anti-lock function of the ABS system. If one of these happens, have the system inspected by your MARUTI dealer.

## Malfunction Indicator Light



63J031

Your vehicle has a computer-controlled emission control system. A malfunction indicator light is provided on the instrument panel to indicate when it is necessary to have the emission control system serviced. The malfunction indicator light comes on when the ignition switch is turned to "ON" or "START" and goes out when the engine is started.

If the malfunction indicator light comes on when the engine is running, there is a problem with the emission control system. Bring the vehicle to your MARUTI dealer to have the problem corrected.

### CAUTION

**Continuing to drive the vehicle when the malfunction indicator light is on can cause permanent damage to the vehicle's emission control system, and can affect fuel economy and driveability.**

## Open Door Warning Light (if equipped)



54G391

This light remains on until all doors (including the tailgate) are completely closed.

## Electric Power Steering Light (if equipped)

# EPS

75F002

This light comes on when the ignition switch is turned to the "ON" position, and goes out when the engine is started.

If this light comes on while driving, the power steering system may not work properly. Have the system inspected by your MARUTI dealer.

### NOTE:

*If the power steering system does not work properly, you will feel heavier to steer but you still will be able to steer.*

**CAUTION**

Keep track of your odometer reading and check the maintenance schedule regularly for required services. Increased wear or damage to certain parts can result from failure to perform required services at the proper mileage intervals.

**EXAMPLE**

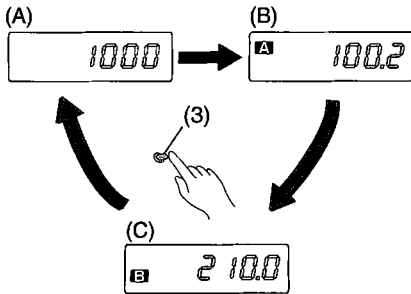

65D603

When the ignition switch is turned to "ON" with the lighting switch is in the "OFF" position, the display shows three types of indication; odometer (A), trip meter A (B) and trip meter B (C). Push the selector knob (3) quickly to switch the indication among the three.

**EXAMPLE**

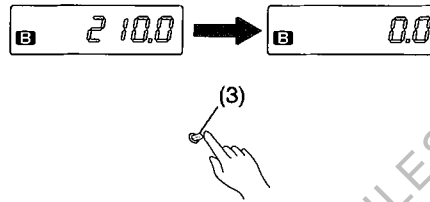

65D481

To reset the trip meter to zero, hold in the selector knob (3) for about 2 seconds.

**Tachometer (if equipped)**

**EXAMPLE**

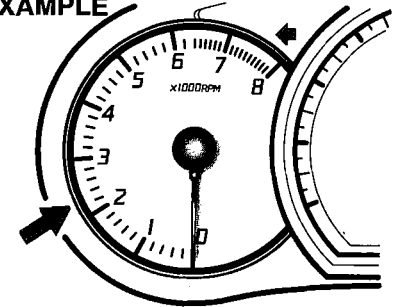

63J034

The tachometer indicates engine speed in revolutions per minute.

**CAUTION**

Never drive with the engine speed indicator in the red zone or severe engine damage can result.

**Heated Rear Window Switch  
(if equipped)**

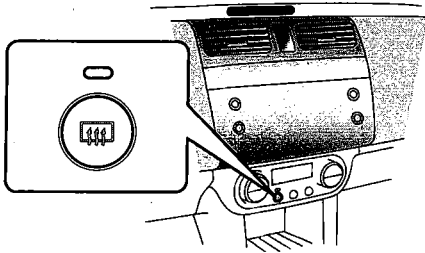

77J019

When the rear window is misted, push this switch to clear the window. An indicator light will be lit when the demister is on. The demister will only work when the ignition switch is in the "ON" position. To turn off the demister, push the switch again.

**CAUTION**

**The heated rear window uses a large amount of electricity. Be sure to turn off after the window has become clear.**

**Headlight Leveling Switch  
(if equipped)**

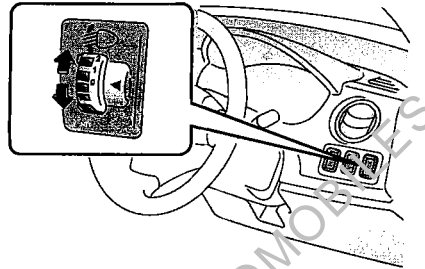

75J016

Level the headlight beam according to the load condition of your vehicle by turning this switch. The chart below shows the appropriate switch position for different vehicle-load conditions.

Vehicle Load Condition	Switch Position
Driver only	0
Driver + 1 passenger (in front seat)	0
Driver + 4 passengers, no cargo	2
Driver + 4 passengers, cargo added	3
Driver + full cargo	4

## Heating and Air Conditioning System

There are two types of heating and air conditioning systems as follows:

- Manual Heating and Air Conditioning System
- Automatic Heating and Air Conditioning System (Climate Control)

### Air Outlet

#### EXAMPLE

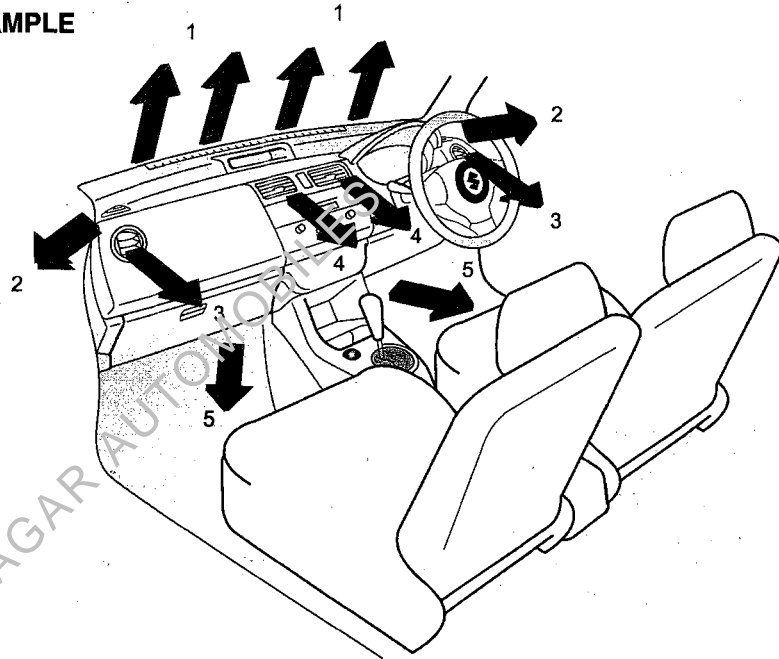

1. Windscreen demister outlet
2. Side demister outlet
3. Side outlet
4. Centre outlet
5. Floor outlet

75J022

## Bi-level (b)

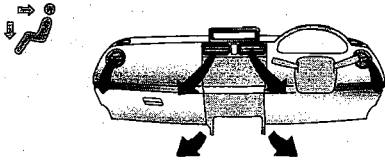

63J137

Temperature-controlled air comes out of the floor outlets and cooler air comes out of the centre and side outlets. When the temperature selector (1) is in the fully COLD position or fully HOT position, however, the air from the floor outlets and the air from the centre and side outlets will be the same temperature.

## Heat (c)

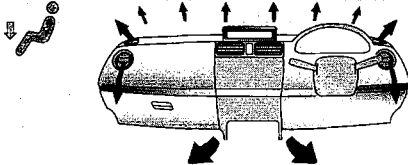

63J138

Temperature-controlled air comes out of the floor outlets and the side outlets, also comes out of the windscreen demister outlets and the side demister outlets slightly.

## Heat & demist (d)

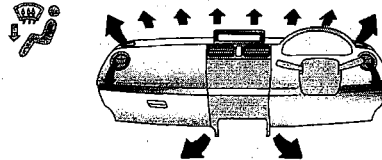

63J139

Temperature-controlled air comes out of the floor outlets, the windscreen demister outlets, the side demister outlets and the side outlets.

## Demist (e)

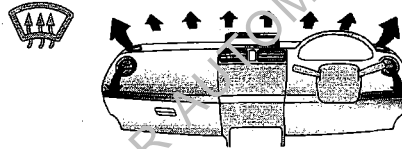

63J140

Temperature-controlled air comes out of the windscreen demister outlets, the side demister outlets and the side outlets.

## Air intake selector (4)

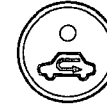

(f)



(g)

63J047

This selector is used to select the following modes.

### Fresh Air (f)

When this mode is selected, the indicator light will go off and outside air is used.

### Recirculated Air (g)

When this mode is selected, the indicator light will come on, outside air is shut out and inside air is recirculated. This mode is suitable when driving through dusty or polluted air such as in a tunnel, or when attempting to quickly cool down the interior.

"FRESH AIR" and "RECIRCULATED AIR" are switched alternately each time the air intake selector is pushed.

### NOTE:

*If you select "RECIRCULATED AIR" for an extended period of time, the air in the vehicle can become contaminated. Therefore, you should occasionally select "FRESH AIR".*

## Automatic Heating and Air Conditioning System (Climate Control) if equipped

### Description of Controls

#### EXAMPLE

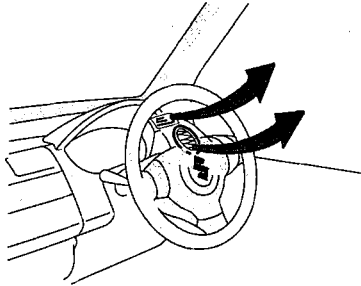

63J049

**NOTE:**

*If you need maximum demisting:*

- set the air flow selector to "DEMIST",
- set the blower speed selector to HIGH,
- adjust the temperature selector to the HOT end, and
- adjust the side outlets so the air blows on the side windows.

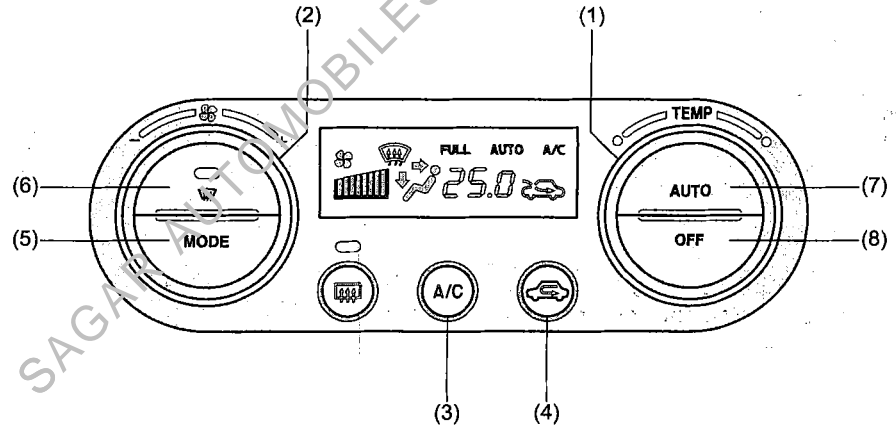

77J041

## Demister switch (6)

This is used to clear the windscreen and side windows by pushing the switch. When the demister switch is on, the indicator light above the demister switch will come on and the demister display is shown in the display.

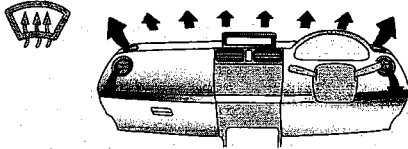

63J140

When turning the demister switch (6) on, temperature-controlled air comes out of the windscreen demister outlets, the side demister outlets and the side outlets. Also, the air conditioning system will come on and the "FRESH AIR" mode will be selected automatically. But in very cold weather, the air conditioning system will not turn on.

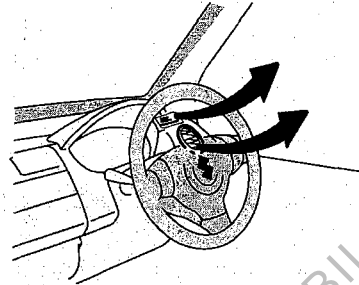

63J049

## "AUTO" switch (7)

This is used to let the climate control system work automatically. When pushing the switch, the blower speed selector, air intake selector and MODE (air flow) selector are controlled automatically to maintain the set temperature. For details on how to set the climate control system in fully automatic operation, refer to the "System Operating Instructions" below.

## "OFF" switch (8)

This is used to turn off the climate control system.

### NOTE:

*If you need maximum demisting:*

- *turn the demister switch on (the air conditioning system will come on and the "FRESH AIR" mode will be selected automatically),*
- *set the blower speed selector to HIGH,*
- *adjust the temperature selector to the HOT end, and*
- *adjust the side outlets so the air blows on the side windows.*

delay turning on the blower until warmed or chilled air is available.

- If your vehicle has been left in the sun with the windows closed, it will cool faster if you open the windows briefly.
- Even under the automatic operation, you can set some of the blower speed selector (2) and MODE (air flow) selector (5) into manual mode. Then the manually selected function is maintained preferentially, and the other functions remain under automatic operation. In this case, the "FULL AUTO" indicator in the display will go out.
- Even under the automatic operation, you can select "FRESH AIR" or "RECIRCULATED AIR" manually. Then the selected air is maintained preferentially, and the other functions remain under automatic operation. In this case, the "FULL" indicator in the display will go out.
- Even if the engine is turned off, the temperature setting remains in the memory.
- When turning the demister switch (6) on under the automatic operation, the blower speed will be increased, "FRESH AIR" mode will be selected and the air conditioning system will turn on. In this case, the "FULL AUTO" indicator will go out. When turning the demister switch off, it will be returned to the previous setting.
- With the air conditioning switch turned off, it is not possible to lower the inside

temperature below the outside temperature.

- If the "AUTO" indicator in the display blinks with the ignition switch in the "ON" position, there is a problem with the air conditioning system. Bring the vehicle to your MARUTI dealer to have the problem corrected.

### Manual Operation

You can manually control the climate control system. Set the selectors to your desired position.

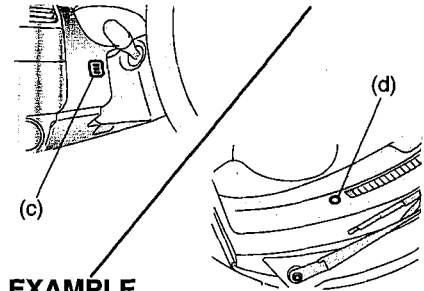

**EXAMPLE**

75J020

Be careful not to cover the interior temperature sensor (c) between the steering wheel and the climate control panel, or the solar sensor (d) located at the top of the driver's side dashboard. These sensors are used by the automatic system to regulate temperature.

## OTHER CONTROLS AND EQUIPMENT

Parking Brake Lever .....	4-1
Pedal .....	4-2
Gear Lever .....	4-2
Fuel Filler Cap .....	4-3
Folding Rear Seats .....	4-4
Sun Visor .....	4-5
Interior Light Switch .....	4-5
Accessory Socket (if equipped) .....	4-6
Cigarette Lighter and Ashtray (if equipped) .....	4-6
Assist Grips (if equipped) .....	4-7
Bonnet .....	4-7
Cup Holder (if equipped) .....	4-8
Frame Hooks .....	4-9
Tyre Changing Tool .....	4-11
Front Seat Back Pocket (if equipped) .....	4-12
Luggage Compartment Cover (if equipped) .....	4-12
Luggage Compartment Light .....	4-13
Radio Antenna (if equipped) .....	4-13

## Pedal

### EXAMPLE

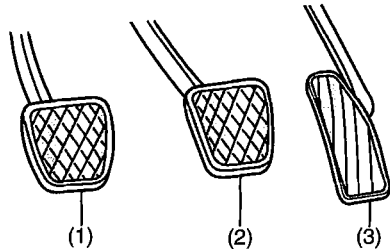

54G040

## Brake Pedal (2)

Your MARUTI vehicle is equipped with front disc brakes and rear drum brakes. Depressing the brake pedal applies both sets of brakes.

You may hear occasional brake squeal when you apply the brakes. This is a normal condition caused by environmental factors such as cold, wet, snow, etc.

### ▲ WARNING

If brake squeal is excessive and occurs each time the brakes are applied, you should have the brakes checked by your MARUTI dealer.

### ▲ WARNING

Do not "ride" the brakes by applying them continuously or resting your foot on the pedal. This will result in overheating of the brakes which could cause unpredictable braking action, longer stopping distances, or permanent brake damage.

## Accelerator Pedal (3)

This pedal controls the speed of the engine. Depressing the accelerator pedal increases power output and speed.

## Clutch Pedal (1)

The clutch pedal is used to disengage the drive to the wheels when starting the engine, stopping, or shifting the transmission lever. Depressing the pedal disengages the clutch.

### CAUTION

Do not drive with your foot resting on the clutch pedal. It could result in excessive clutch wear, clutch damage, or unexpected loss of engine braking.

## Gear Lever

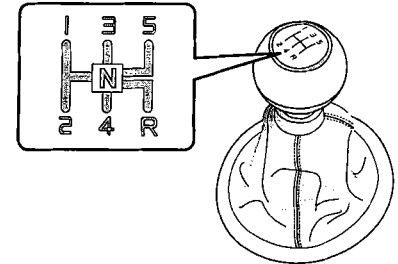

63J051

Your vehicle is equipped with a manual transmission. The gear lever is shown. For details on how to use the transmission, refer to "Using the Transmission" in the "OPERATING YOUR VEHICLE" section.

## Folding Rear Seats

The rear seat(s) of your vehicle can be folded forward to provide additional cargo space.

To fold the rear seats forward:

### EXAMPLE

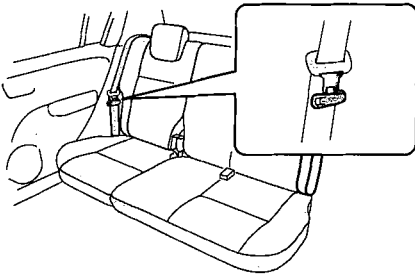

62J059

- 1) Hook the webbing and the latch plate of the outboard lap-shoulder belt in the belt hangers.

### CAUTION

- When you move a seatback, make sure both the latch plate and the belt webbing are hooked in the seat belt hangers so the seat belts are not caught by the seatback, seat hinge, or seat latch. This helps prevent damage to the belt system.

(Continued)

### CAUTION

(Continued)

- When you hook the belt webbing and latch plate into the seat belt hanger, make sure the latch plate is on the obverse side of the belt webbing as shown in the illustration.
- Make sure the belt webbing is not twisted.

- 2) Lower the adjustable head restraint fully (if equipped).

### EXAMPLE

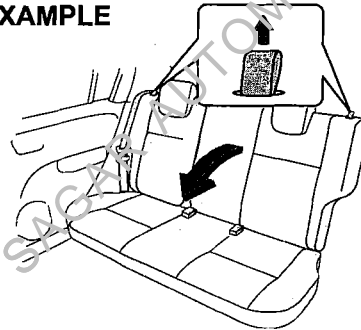

75J023

- 3) Pull the both release straps on the top of the seatback, and fold the seatback forward.

### CAUTION

After folding the rear seatback forward, do not allow any foreign material to enter the lock opening. This may cause damage to the inside of the lock and prevent the seatback from being locked securely.

### WARNING

Luggage or other cargo should be stowed in the luggage compartment with the rear seat in an upright position, whenever possible. If you need to carry cargo in the passenger compartment with the rear seat back folded forward, be sure to secure the cargo or it may be thrown about, causing injury. Never pile cargo higher than the seatbacks.

EXAMPLE

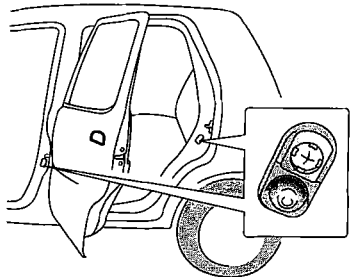

63J061

Accessory Socket  
(if equipped)

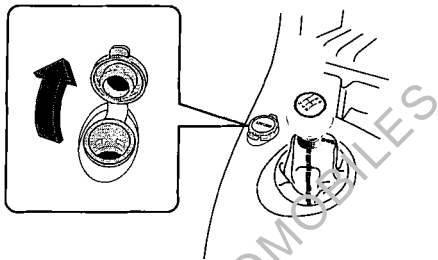

63J062

This socket can be used to provide 12 volt/120 watt power for electrical accessories.

**CAUTION**

Use of inappropriate electrical accessories can cause damage to your vehicle's electrical system. Make sure that any electrical accessories you use are designed to plug into this type of socket.

Cigarette Lighter and Ashtray  
(if equipped)

EXAMPLE

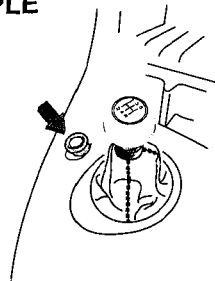

63J040

**Cigarette lighter**

To use the cigarette lighter, push it all the way into the receptacle and release it. It will automatically heat up and will pop out to its normal position when it is ready for use.

**CAUTION**

To avoid damage to the cigarette lighter socket, do not use it as other accessories' power source. Some accessories' power plug can damage the inner mechanism of the cigarette lighter socket.

**NOTE:**

The number of doors involved in the lighting operation of the interior light depends on the vehicle specification. If there is a switch (rubber projection) at the door opening as shown, the door is involved in the lighting operation. The tailgate is also involved in this operation even without the rubber projection.

Cup Holder (if equipped)

Front

EXAMPLE

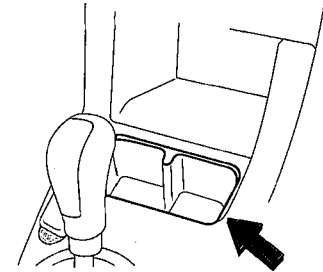

62J096

Rear

EXAMPLE

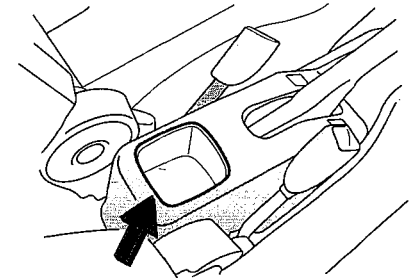

63J067

The cup holders are provided in the centre console.

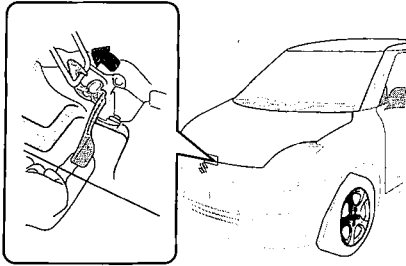

63J064

- 2) Push the under-bonnet release lever up with your finger, as shown in the illustration. While pushing the lever, lift up the bonnet.

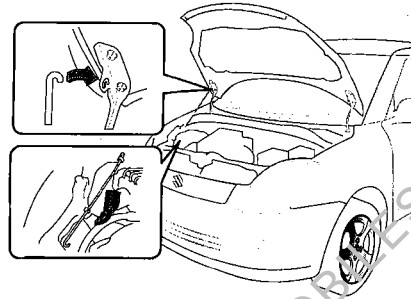

63J065

- 3) Continue to lift up the bonnet until it is high enough to support with the prop rod.

To close the bonnet:

- 1) Lift the bonnet up slightly and remove the prop rod from the hole. Put the prop rod back to the holding clip.
- 2) Lower the bonnet close to the bumper, then let it drop down. Make sure the bonnet is securely latched after closing.

**⚠ WARNING**

**Make sure the bonnet is fully closed and latched before driving. If it is not, it can fly up unexpectedly during driving, obstructing your view and resulting in an accident.**

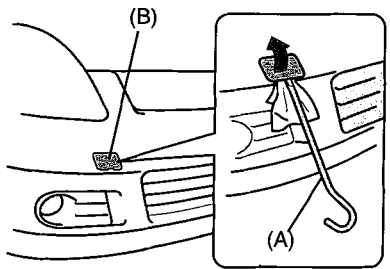

63J119

2) Remove the cover (B) by using a jack handle (A) covered with a soft cloth as shown in the illustration.

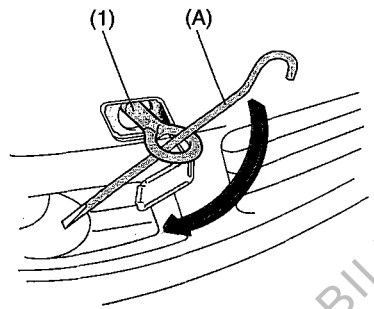

63J121

4) To tighten the towing hook (1), turn it clockwise by using a jack handle (A) until the hook (1) is securely installed.

To remove the towing hook (1), reverse the procedure used to install the towing hook.

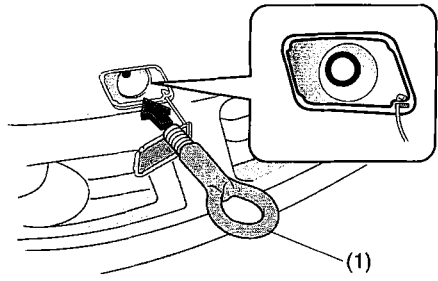

63J120

3) Install the towing hook (1) by hand.

Rear

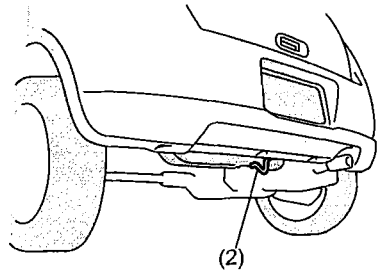

63J122

The frame hook (2) is provided on the rear of the vehicle for use in emergency situations.

To tow your vehicle on the road or highway, follow the instruction of "Towing" in "EMERGENCY SERVICE" or "VEHICLE LOADING AND TOWING" section.

**⚠ WARNING**

**Do not use the hooks (1) and (2) to tow (or be towed by) another vehicle on the road or highway. These hooks are designed for use in emergency situations and sea shipping purposes only.**

the storage bracket and turn the shaft clockwise until the jack is securely held in place.

**⚠ WARNING**

The jack should be used only to change wheels. It is important to read the jacking instructions in the "EMERGENCY SERVICE" section of this manual before attempting to use the jack.

**⚠ WARNING**

After using the tyre changing tools, be sure to stow them securely or they can cause injury if an accident occurs.

**Front Seat Back Pocket  
(if equipped)**

**EXAMPLE**

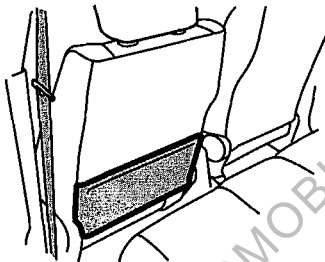

64J127

This pocket is provided for holding light and soft things such as gloves, newspapers or magazines.

**⚠ WARNING**

Do not put hard or breakable objects in the pocket. If an accident occurs, objects such as bottles, cans, etc. can injure the occupants in the rear seat.

**Luggage Compartment Cover  
(if equipped)**

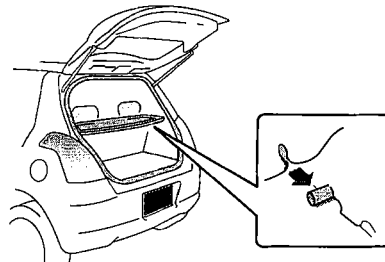

63J074

Luggage or other cargo placed in the luggage compartment are hidden from view by a luggage compartment cover.

**⚠ WARNING**

Do not carry items on top of the luggage compartment cover, even if they are small and light. Objects on top of the cover could be thrown about in an accident, causing injury, or could obstruct the driver's rear view.

## OPERATING YOUR VEHICLE

Exhaust Gas Warning .....	5-1
Daily Inspection Checklist .....	5-1
Engine Oil Consumption .....	5-2
Starting the Engine .....	5-3
Using the Transmission .....	5-4
Braking .....	5-5
Running-in .....	5-7
Catalytic Converter (if equipped) .....	5-7
Improving Fuel Economy .....	5-8

SAGAR AUTOMOBILES

- 4) Make sure the bonnet is fully closed and latched.
- 5) Check the headlights, turn signal lights, brake lights and horn for proper operation.
- 6) Adjust the seat and adjustable head restraint (if equipped).
- 7) Check the brake pedal and the parking brake lever.
- 8) Adjust the mirrors.
- 9) Make sure that you and all passengers have properly fastened your seat belts.
- 10) Make sure that all warning lights come on as the key is turned to the "ON" or "START" position.
- 11) Check all gauges.
- 12) Make sure that the BRAKE SYSTEM WARNING light turns off when the parking brake is released.

Once a week, or each time you fill your fuel tank, perform the following under-bonnet checks:

- 1) Engine oil level
- 2) Coolant level
- 3) Brake fluid level
- 4) Windscreen washer fluid level
- 5) Battery solution level
- 6) Bonnet latch operation

Pull the bonnet release handle inside the vehicle. Make sure that you cannot open the bonnet all the way without releasing the secondary latch. Be sure to close the bonnet securely after checking for proper latch operation.

See "All latches, hinges & locks" of "CHASSIS AND BODY" in the "Periodic Maintenance Schedule" in the "INSPECTION AND MAINTENANCE" section for lubrication schedule.

### WARNING

**Make sure the bonnet is fully closed and latched before driving. If it is not, it can fly up unexpectedly during driving, obstructing your view and resulting in an accident.**

Once a month, or each time you fill your fuel tank, check the tyre pressure using a tyre pressure gauge. Also check the tyre pressure of the spare tyre.

## Engine Oil Consumption

It is normal for the engine to consume some engine oil during normal vehicle operation.

The amount of engine oil consumed depends on the viscosity of the oil, the quality of the oil and the conditions the vehicle is driven under.

More oil is consumed during high-speed driving and when there is frequent acceleration and deceleration. Under high loads, your engine also will consume more oil.

A new engine also consumes more oil, since its pistons, piston rings and cylinder walls have not yet become conditioned. New engines reach the normal level of oil consumption only after approximately 5000 km (3000 miles) driving.

When judging the amount of oil consumption, note that the oil may become diluted and make it difficult to accurately judge the true oil level.

As an example, if a vehicle is used for repeated short trips, and consumes a normal amount of oil, the dipstick may not show any drop in the oil level at all, even after 1000 km (600 miles) or more of driving. This is because the oil is gradually becoming diluted with fuel or moisture, making it appear that the oil level has not changed.

You should also be aware that the diluting ingredients evaporate out when the vehicle is subsequently driven at high speeds,

## Using the Transmission

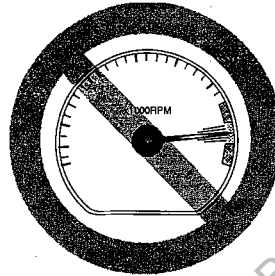
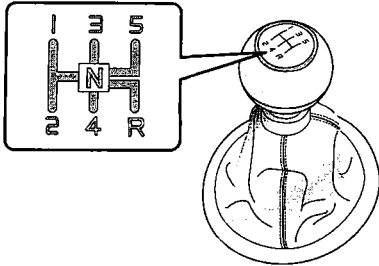

54G263

63J051

Keep the engine speed so it does not get into the red zone of tachometer.

### Starting off

To start off, push in the clutch pedal and change into 1st gear. After releasing the parking brake, gradually release the clutch. When you hear a change in the engine's sound, slowly press the accelerator while continuing to gradually release the clutch.

### Gear changing

All forward gears are synchronized, which provides for quiet, easy changing. Always push in the clutch pedal fully before changing gears.

### CAUTION

- To help avoid clutch damage, do not use the clutch pedal as a footrest while driving or use the clutch to keep the vehicle stationary on a hill. Depress the clutch fully when changing gear.
- When changing gears or starting off, do not race the engine. Racing the engine can shorten engine life and prevent smooth operation.

### ⚠ WARNING

- Reduce your speed and change down to a lower gear before going down a long or steep hill. A lower gear will allow the engine to provide braking. Avoid riding the brakes or they may overheat, resulting in brake failure.
- When driving on slippery roads, be sure to slow down before changing down. Excessive and or sudden changes in engine speed may cause loss of traction, which could cause you to lose control.
- Make sure that the vehicle is completely stationary before you change into reverse.

**▲ WARNING**

- On some types of loose surfaces (such as gravel, snow-covered roads, etc.) the stopping distance required for an ABS-equipped vehicle may be slightly greater than for a comparable vehicle with a conventional brake system. With a conventional brake system, skidding tyres are able to “plow” the gravel or snow layer, shortening the stopping distance, ABS minimizes this resistance effect. Allow for extra stopping distance when driving on loose surfaces.
- On regular paved roads, some drivers may be able to obtain slightly shorter stopping distances with conventional brake systems than with ABS.
- In both of the above conditions, ABS will still offer the advantage of helping you maintain directional control. However, remember that ABS will not compensate for bad road or weather conditions or poor driver judgment. Use good judgment and do not drive faster than conditions will safely allow.

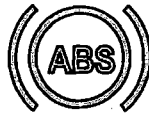

(1)



(2)

63J081

- (1) ABS warning light
- (2) Brake system warning light

**▲ WARNING**

- If the ABS warning light (1) on the instrument panel comes on and stays on while driving, there may be a problem with the ABS system. Ask your MARUTI dealer to inspect the ABS system immediately. If the ABS system becomes inoperative, the brake system will function as an ordinary brake system that has no ABS.

(Continued)

**▲ WARNING**

(Continued)

- If the ABS warning light (1) and the Brake system warning light (2) on the instrument panel simultaneously stays on or comes on when driving, both anti-lock function and rear brake force control function (Proportioning valve function) of the ABS system may have failed. If so, the rear wheels may easily skid or the vehicle can even spin in the worst case when braking on a slippery road or when hard braking even on a dry paved road. Ask your MARUTI dealer to inspect the ABS system immediately. Drive carefully, avoiding hard braking as much as possible.

to the catalyst and other vehicle components.

### CAUTION

To minimize the possibility of catalyst or other vehicle damage:

- Maintain the engine in the proper operating condition.
- In the event of an engine malfunction, particularly one involving engine misfire or other apparent loss of performance, have the vehicle serviced promptly.
- Do not turn off the engine or interrupt the ignition when the transmission is in gear and the vehicle is in motion.
- Do not try to start the engine by pushing or towing the vehicle, or coasting down a hill.
- Do not idle the engine with any spark plug wires disconnected or removed, such as during diagnostic testing.
- Do not idle the vehicle for prolonged periods if idling seems rough or there are other malfunctions.
- Do not allow the fuel tank to get near the empty level.

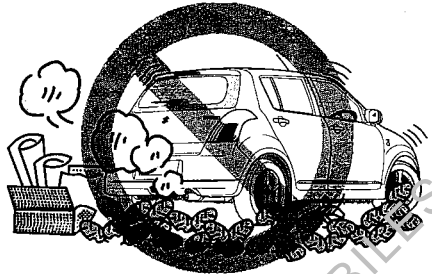

54G071S

### ⚠ WARNING

Be careful where you park and drive; the catalytic converter and other exhaust components can get very hot. As with any vehicle, do not park or operate this vehicle in areas where combustible materials such as dry grass or leaves can come in contact with a hot exhaust system.

## Improving Fuel Economy

The following instructions will help you improve fuel economy.

### Avoid excessive idling

If you are to wait for more than a minute while you are parked, stop the engine and start it again later. When warming up a cold engine, allow the engine to idle until the temperature gauge pointer comes up to the "C" position (if the idling is not prohibited). In this position, the engine is sufficiently warm for starting off.

### Avoid "fast" starts

Fast starts away from lights or stop signs will consume fuel unnecessarily and shorten engine life. Start off slowly.

### Avoid unnecessary stops

Avoid unnecessary deceleration and stopping. Try to maintain a slow, steady speed whenever possible. Slowing down and then accelerating again uses more fuel.

### Keep a steady cruising speed

Keep as constant a speed as road and traffic conditions will permit.

## DRIVING TIPS

High-Speed Driving .....	6-1
Driving on Hills .....	6-1
Driving on Slippery Roads .....	6-2

SAGAR AUTOMOBILES

**▲ WARNING**

Try not to hold the brake pedal down too long or too often while going down a steep or long hill. This could cause the brakes to overheat, resulting in reduced braking efficiency. Failure to take this precaution could result in loss of vehicle control.

**CAUTION**

When descending a down hill, **NEVER** turn the ignition key to the "OFF" position. Emission control system damage may result.

**Driving on Slippery Roads**

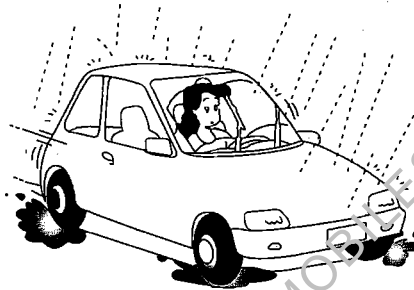

60G089S

Under wet road conditions you should drive at a lower speed than on dry roads due to possible slippage of tyres during braking. When driving on icy, snow-covered, or muddy roads, reduce your speed and avoid sudden acceleration, abrupt braking, or sharp steering movements.

**If Your Vehicle Gets Stuck**

If your vehicle gets stuck in snow, mud, or sand, follow the directions below:

- 1) Change back and forth between first gear and reverse. This will create a rocking motion which may give you enough momentum to free the vehicle. Press gently on the accelerator to keep wheel spin to a minimum. Remove your foot from the accelerator while changing gear.

Do not race the engine. Excessive wheel spin will cause the tyres to dig deeper, making it more difficult to free the vehicle.

- 2) If your vehicle remains stuck after a few minutes of rocking, get another vehicle to pull you out.

**▲ WARNING**

Do not allow anyone to stand near the vehicle when you are rocking it, and do not spin the wheels faster than an indicated 40 km/h (25 mph) on the speedometer. Personal injury and/ or vehicle damage may result from spinning the wheels too fast.

**CAUTION**

Do not continue rocking the vehicle for more than a few minutes. Prolonged rocking can cause engine overheating or transmission damage.

## VEHICLE LOADING AND TOWING

Vehicle Loading .....	7-1
Trailer Towing .....	7-1
Towing Your Vehicle (recreational towing) .....	7-5

SAGAR AUTOMOBILES

Some countries have regulations which specifically allow trailer towing up to a specified maximum trailer weight (registered or statutory towing capacity, whichever is smaller); vehicles sold in these countries can be used to tow a light trailer, provided the trailer does not exceed the maximum trailer weight specified in the country's regulations.

If you use your MARUTI to tow a trailer, you should always observe the requirements and recommendations in this section. If you intend to tow a trailer, it is essential to select a trailer and trailer towing equipment which are compatible. A reputable towing specialist can help you.

### CAUTION

**Trailer towing puts additional stress on the engine, drive train, and brakes of your vehicle. Never tow a trailer during the first 960 km (600 miles) of vehicle operation.**

### Brakes

#### WARNING

**If trailer brakes are used, you should follow all instructions provided by the manufacturer. Never connect to the brake system of your vehicle and never take an electrical supply directly from the wiring harness.**

### Tyres

#### WARNING

**When towing a trailer, it is very important for your vehicle and trailer to have properly inflated tyres. Your vehicle's tyres should be inflated to the pressures listed on your vehicles Tyre Information label. If laden pressures are listed on the label, the tyres should be inflated to the laden pressures. Inflate trailer tyres according to the specifications provided by the trailer manufacturer.**

### Mirrors

Check to see if your vehicle's mirrors meet local requirements for mirrors used on towing vehicles. If they do not, you must install the required mirrors before you tow.

SAGAR AUTOMOBILES

**⚠ WARNING**

Your vehicle will handle differently when towing a trailer. For your safety and the safety of others, you should observe the following precautions:

- Practice turning, stopping, and reversing before you begin towing in traffic. Do not tow in traffic until you are confident that you can handle the vehicle and trailer safely.
- Never exceed towing speed limits or 80 km/h (50 mph), whichever is lower.
- Never drive at a speed that causes shaking or swaying of the trailer. If you notice even the slightest sign of shaking or swaying, slow down.
- When roads are wet, slippery or rough, drive at a slower speed than you would on dry, smooth roads. Failure to slow down when road conditions are bad can result in loss of control.
- Always have someone guide you when reversing.
- Allow adequate stopping distance. Stopping distance is increased when you tow a trailer. For each 16 km/h (10 mph) of speed, allow at least one vehicle and trailer length between you and the vehicle ahead. Follow at a greater distance if roads are wet or slippery.

(Continued)

**⚠ WARNING**

(Continued)

- If the trailer has over-run brakes, apply the brakes gradually to avoid snatching caused by the trailer wheels locking.
- Slow down before corners and maintain a steady speed while cornering. Deceleration or acceleration while cornering can result in loss of control. Remember that a larger than normal turning radius is needed because the trailer wheels will be closer than vehicle wheels to the inside of the turn.
- Avoid sudden acceleration and stopping of the vehicle. Do not make quick maneuvers unless they are necessary.
- Slow down in cross winds and be prepared for gusts of wind from large passing vehicles.
- Be careful when overtaking other vehicles. Be sure to allow enough room for your trailer before you change lanes, and signal well in advance.
- Slow down and change into a lower gear before you reach long or steep downhill grades. It is hazardous to attempt changing down while you are descending a hill.

(Continued)

**⚠ WARNING**

(Continued)

- Avoid “riding” the brakes. This could cause the brakes to overheat resulting in reduced braking efficiency. Use engine braking as much as possible.
- Because of the added trailer weight, your engine may overheat on hot days when going up long or steep hills. Pay attention to your engine temperature gauge. If it indicates overheating, pull off the road and stop in a safe place. Refer to “If the Engine Overheats” in “EMERGENCY SERVICE” section.

**⚠ WARNING**

When you tow your vehicle, follow the instructions below to avoid accidents and damage to your vehicle. In addition, be sure to observe government and local requirements regarding vehicle lighting and trailer hitches or tow bars.

**TOWING INSTRUCTION TABLE**

DRIVE TRAIN	TRANSMISSION	TOWING METHOD
2WD	M/T (MANUAL)	A / B

SAGAR AUTOMOBILES

## INSPECTION AND MAINTENANCE

Maintenance Schedule .....	8-2
Periodic Maintenance Schedule .....	8-2
Drive Belt .....	8-6
Engine Oil and Filter .....	8-6
Gear Oil .....	8-9
Engine Coolant .....	8-10
Windscreen Washer Fluid .....	8-12
Air Cleaner .....	8-12
Spark Plugs .....	8-13
Brakes .....	8-15
Steering .....	8-17
Clutch Pedal .....	8-17
Tyres .....	8-17
Battery .....	8-21
Fuses .....	8-21
Bulb Replacement .....	8-24
Wiper Blades .....	8-28
Air Conditioning System .....	8-31

**Maintenance Schedule**

**EXAMPLE**

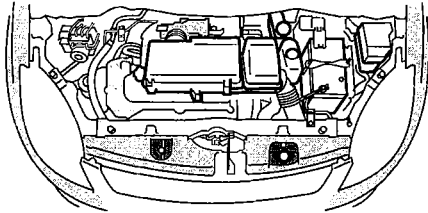

77J030

The following table shows the times when you should perform regular maintenance on your vehicle. This table shows in kilometers and months when you should perform inspections, adjustments, lubrication and other services.

**▲ WARNING**  
 MARUTI recommends that maintenance on your MARUTI vehicle be performed by MARUTI authorised Dealer/Service Station.

**CAUTION**  
 Whenever it becomes necessary to replace parts on your vehicle, it is recommended that you use MARUTI GENUINE PARTS (MGP) only.

SAGAR AUTOMOBILES

**Periodic Maintenance Schedule**

- “A” : Adjust
- “C” : Clean
- “R” : Replace or Change
- “I” : Inspect and correct or replace if necessary
- “L” : Lubricate
- “T” : Tighten

**NOTE:**  
 This table includes services as scheduled up to 80,000 km mileage. Beyond 80,000 km, carry out the same services at the same intervals respectively.

## INSPECTION AND MAINTENANCE

Interval: This interval should be judged by odometer reading or months, whichever comes first.	FREE INSPECTION			PERIODIC MAINTENANCE AT COST								
	km (x1000)	1	5	10	20	30	40	50	60	70	80	
	months	1	6	12	24	36	48	60	72	84	96	
<b>BRAKE</b>												
6-1. Brake Fluid (Level, Leakage)		I	I	I	R	I	R	I	R	I	I	
6-2. Brake pedal (pedal - wall clearance)		I	I	I	I	I	I	I	I	I	I	
6-3. Parking brake lever and cable (Play, damage)		I	I	I	I	I	I	I	I	I	I	
6-4. Brake disc and pad (Wear)		-	I	I	I	I	I	I	I	I	I	
6-5. Brake drum and shoes (Wear)		-	-	I	I	I	I	I	I	I	I	
6-6. Master cylinder/wheel cylinder/calliper (Oil leakage, boot cut)		I	I	I	I	I	R	I	I	I	R	
6-7. Brake hoses and pipes (Leakage, damage)		I	I	I	I	I	I	I	I	I	I	
<b>WHEEL</b>												
7-1. Tyres (air pressure, abnormal wear, crack and rotation)		Rotate and inspect after every 5,000 KM.										
7-2. Wheels (Damage)		I	I	I	I	I	I	I	I	I	I	
7-3. Front/Rear wheel bearing (Loose, damage)		I	I	I	I	I	I	I	I	I	I	
<b>FRONT / REAR SUSPENSION</b>												
8-1. Suspension strut (Oil leakage, damage)		Clean & inspect after every 5,000 KM.										
8-2. Suspension arms / Knuckle support (Loose, damage)		I	I	I	I	I	I	I	I	I	I	
8-3. Rear spring (Damage)		I	I	I	I	I	I	I	I	I	I	
8-4. Shock absorbers (Oil leakage, damage)		I	I	I	I	I	I	I	I	I	I	
8-5. All bolts and nuts (Loose)		-	T	T	T	T	T	T	T	T	T	
8-6. Suspension arms and torsion rods		-	I	I	I	I	I	I	I	I	I	
<b>STEERING</b>												
9-1. Steering wheel (Play, loose)		I	I	I	I	I	I	I	I	I	I	
9-2. All rods and arms (Loose, damage, wear)		I	I	I	I	I	I	I	I	I	I	
<b>ELECTRICAL</b>												
10-1. Battery electrolyte (Level, leakage)		I	I	I	I	I	I	I	I	I	I	
10-2. Wiring harness connection (Loose, damage)		-	I	I	I	I	I	I	I	I	I	
10-3. Lightening system (Operation, stains, damage)		I	I	I	I	I	I	I	I	I	I	
10-4. Horn (Operation)		I	I	I	I	I	I	I	I	I	I	
10-5. System Voltage		-	I	I	I	I	I	I	I	I	I	

Drive Belt

**⚠ WARNING**

When the engine is running, keep hands, hair, clothing, tools, etc. away from the moving fan and drive belts.

Make sure the drive belt tension is correct. If the belt is too loose, insufficient battery charging, engine overheating, poor power steering, poor air conditioning, or excessive belt wear can result. When you press the belt with your thumb midway between the pulleys, there should be a deflection according to the following chart.

The belts should also be examined to ensure that they are not damaged.

If you need to replace or adjust the belt have it done by your MARUTI dealer.

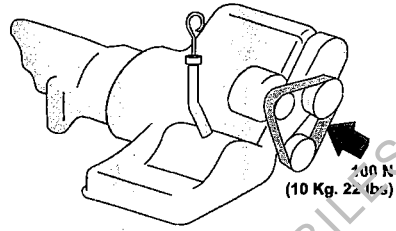

77A023

**Belt deflection:**  
5 – 7 mm (0.20 – 0.28 in.)

**Air conditioner belt**

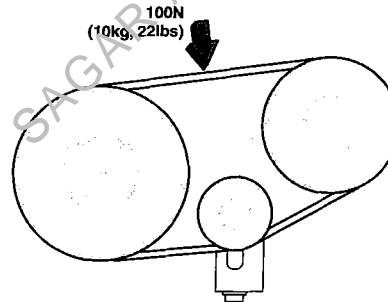

77J047

**Belt deflection:**  
7 – 8 mm (0.28 – 0.31 in.)

Engine Oil and Filter

Specified Oil

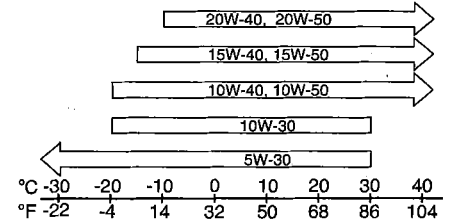

77J048

Be sure that the engine oil you use comes under the quality classification of SE, SF, SG, SH, SJ or SL. Select the appropriate oil viscosity according to the above chart. The recommended Engine Oil is SF 20 W 40.

EXAMPLE

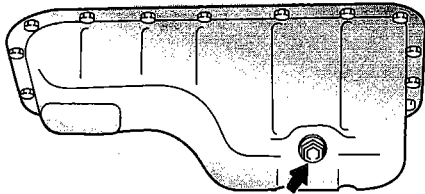

60G306

Tightening torque for drain plug:  
50 Nm (5.0 kg-m, 36.5 lb-ft)

**⚠ WARNING**

New and used oil can be hazardous. Children and pets may be harmed by swallowing new or used oil. Keep new and used oil and used oil filters away from children and pets. Continuous contact with used engine oil has been found to cause [skin] cancer in laboratory animals. Brief contact with used oil may irritate skin.

(Continued)

**⚠ WARNING**

(Continued)  
To minimize your exposure to used oil, wear a long-sleeve shirt and moisture-proof gloves (such as dish-washing gloves) when changing oil. If oil contacts your skin, wash thoroughly with soap and water. Launder any clothing or rags if wet with oil.  
Recycle or properly dispose of used oil and filters.

- 4) Reinstall the drain plug and gasket. Tighten the plug with a wrench to the specified torque.

**Replace the Oil Filter**

- 1) Using an oil filter wrench, turn the oil filter counterclockwise and remove it.
- 2) Using a clean rag, wipe off the mounting surface on the engine where the new filter will be seated.
- 3) Smear a little engine oil around the rubber gasket of the new oil filter.
- 4) Screw on the new filter by hand until the filter gasket contacts the mounting surface.

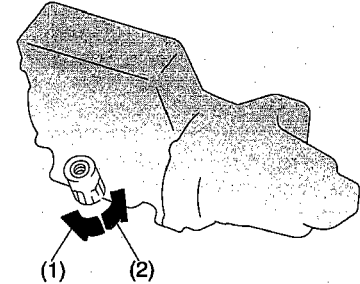

54G092

- (1) Loosen
- (2) Tighten

**Tightening (viewed from filter top)**

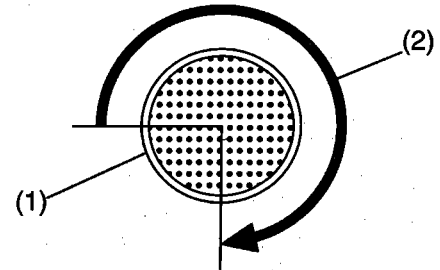

54G093

- (1) Oil filter
- (2) 3/4 turn

tom of the plug hole, the oil level is correct. If so, reinstall the plug.

- 4) If the oil level is low, add gear oil through the oil filler plug hole (1) until the oil level reaches the bottom of the filler hole, then reinstall the plug.

**Tightening torque (1):**  
21 Nm (2.1 kg-m, 15.5 lb-ft)

### ⚠ WARNING

After driving the vehicle, the transmission oil temperature may be high enough to burn you. Wait until the oil filler plug is cool enough to touch with your bare hands before inspecting transmission oil.

### Gear Oil Change

Since special procedures, materials and tools are required, it is recommended that you trust this job to your authorized MARUTI dealer.

## Engine Coolant

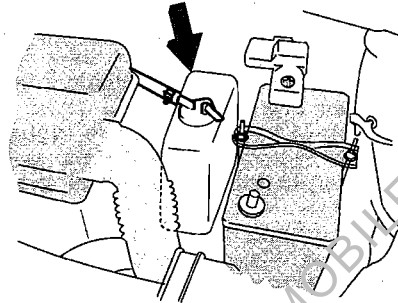

77J032

### EXAMPLE

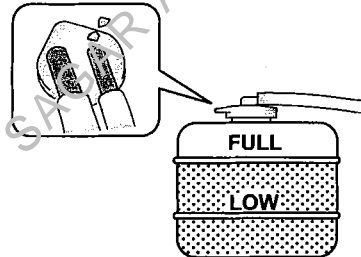

60A208S

## Selection of Coolant

To maintain optimum performance and durability of your engine, use MARUTI Genuine Coolant or equivalent.

This type of coolant is best for your cooling system as it:

- Helps maintain proper engine temperature.
- Gives proper protection against freezing and boiling.
- Gives proper protection against corrosion and rust.

Failure to use the proper coolant can damage your cooling system. Your authorized MARUTI dealer can help you select the proper coolant.

### CAUTION

To avoid damaging your cooling system:

- Always use a high quality ethylene glycol non-silicate based coolant diluted with distilled water at the correct mixture concentration.
- Make sure that the proper mix is 50/50 coolant to distilled water and in no case higher than 70/30. Concentrations greater than 70/30 coolant to distilled water will cause overheating conditions.
- Neither use 100% coolant nor 100% plain water.

(Continued)

## Windscreen Washer Fluid

Front and rear

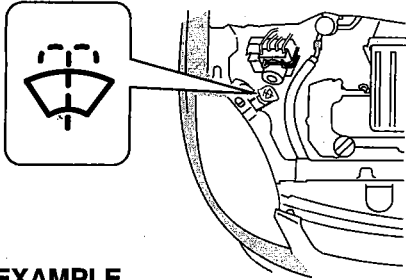

### EXAMPLE

63J089

Check that there is washer fluid in the tank. Refill it if necessary. Use a good quality windscreen washer fluid, diluted with water as necessary.

### ⚠ WARNING

Do not use "antifreeze" solution in the windscreen washer reservoir. This can severely impair visibility when sprayed on the windscreen, and can also damage your vehicle's paint.

### CAUTION

Damage may result if the washer motor is operated with no fluid in the washer tank.

## Air Cleaner

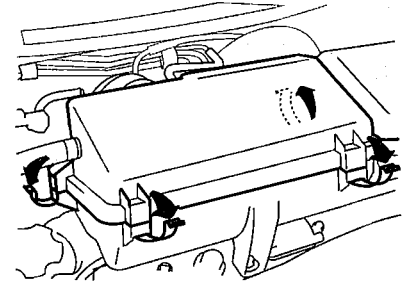

77J033

If the air cleaner is clogged with dust, there will be greater intake resistance, resulting in decreased power output and increased fuel consumption.

Unclamp the side clamps and remove the element from the air cleaner case. If it appears to be dirty, replace it with a new one.

SAGAR AUTOMOBILES

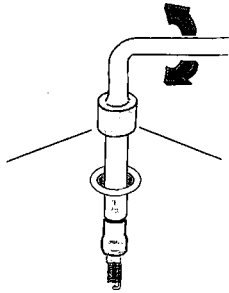

60G160S

**CAUTION**

- When installing the spark plugs, screw them in with your fingers to avoid stripping the threads. Tighten with a torque wrench to 25 Nm (2.5 kg-m, 18.0 lb-ft). Do not allow contaminants to enter the engine through the spark plug holes when the plugs are removed.
- Never use spark plugs with the wrong thread size.

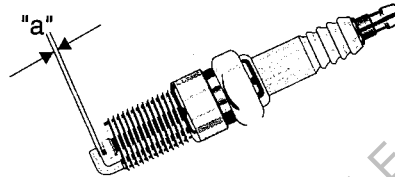

54G106

Spark plug gap "a"  
0.8 – 0.9 mm (0.031 – 0.035 in.)

**CAUTION**

When replacing spark plugs, you should use the brand and type specified for your vehicle. For the specified spark plugs, refer to the "SPECIFICATIONS" section at the end of this book. If you wish to use a brand of spark plug other than the specified plugs, consult your MARUTI dealer.

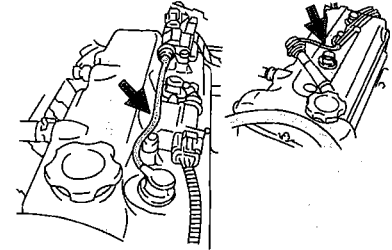

65D204

**NOTE:**

If your engine is equipped with the high-tension cord type ignition wiring and you experience some firing problem of spark plugs, such as, hard engine-starting, mis-fire etc., the cause may be located not only on spark plugs but also on deteriorated ignition wirings (generally, used for more than 80,000 km or five years). If spark plug replacement does not solve the problem, have the ignition wiring and other ignition system inspected by your MARUTI dealer.

Parking Brake

EXAMPLE

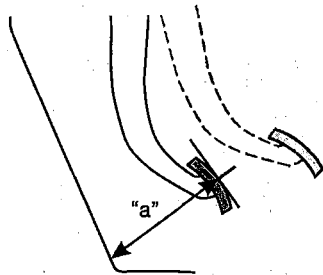

54G108

**Pedal to wall minimum distance "a":  
85 mm (3.3 in.)**

With the engine running, measure the distance between the brake pedal and floor wall when the pedal is depressed with approximately 30 kg (66 lbs) of force. The minimum distance required is as specified. Since your vehicle's brake system is self-adjusting, there is no need for pedal adjustment.

If the pedal to floor wall distance as measured above is less than the minimum distance required, have your vehicle inspected by your MARUTI dealer.

**NOTE:**

*When measuring the distance between the brake pedal and floor wall, be sure not to include the floor mat or rubber on the floor wall in your measurement.*

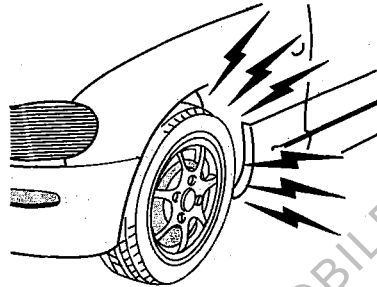

60G104S

**⚠ WARNING**

**If you experience any of the following problems with your vehicle's brake system, have the vehicle inspected immediately by your MARUTI dealer.**

- **Poor braking performance**
- **Uneven braking (Brakes not working uniformly on all wheels.)**
- **Excessive pedal travel**
- **Brake dragging**
- **Excessive noise**
- **Pedal pulsation (Pedal pulsates when depressed.)**

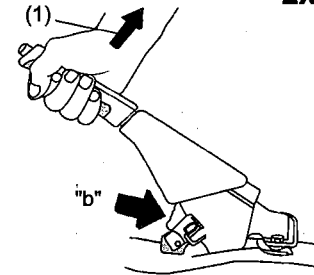

54G109

**Ratchet tooth specification "b":  
4th – 9th  
Lever pull force (1):  
200 N (20 kg, 44 lbs)**

Check the parking brake for proper adjustment by counting the number of clicks made by the ratchet teeth as you slowly pull up on the parking brake lever to the point of full engagement. The parking brake lever should stop between the specified ratchet teeth and the rear wheels should be securely locked. If the parking brake is not properly adjusted or the brakes drag after the lever has been fully released, have the parking brake inspected and/or adjusted by your MARUTI dealer.

**Tyre Inspection**

Inspect your vehicle's tyres at least once a month by performing the following checks:

- 1) Measure the air pressure with a tyre gauge. Adjust the pressure if necessary. Remember to check the spare tyre, too.

**⚠ WARNING**

- Air pressures should be checked when the tyres are cold or you may get inaccurate readings.
- Check the inflation pressure from time to time while inflating the tyre gradually, until the specified pressure is obtained.
- Never underinflate or overinflate the tyres.

Underinflation can cause unusual handling characteristics or can cause the rim to slip on the tyre bead, resulting in an accident or damage to the tyre or rim.

Overinflation can cause the tyre to burst, resulting in personal injury. Overinflation can also cause unusual handling characteristics which may result in an accident.

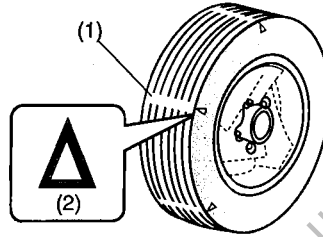
**EXAMPLE**

- (1) Tread wear indicator.
- (2) Indicator location mark.

54G136

- 2) Check that the depth of the tread groove is more than 1.6 mm (0.06 in.). To help you check this, the tyres have molded-in tread wear indicators in the grooves. When the indicators appear on the tread surface, the remaining depth of the tread is 1.6 mm (0.06 in.) or less and the tyre should be replaced.
- 3) Check for abnormal wear, cracks and damage. Any tyres with cracks or other damage should be replaced. If any tyres show abnormal wear, have them inspected by your MARUTI dealer.

**⚠ WARNING**

Hitting curbs and running over rocks can damage tyres and affect wheel alignment. Be sure to have tyres and wheel alignment checked periodically by your MARUTI dealer.

- 4) Check for loose wheel nuts.
- 5) Check that there are no nails, stones or other objects sticking into the tyres.

**⚠ WARNING**

- Your MARUTI is equipped with tyres which are all the same type and size. This is important to ensure proper steering and handling of the vehicle. Never mix tyres of different size or type on the four wheels of your vehicle. The size and type of tyres used should be only those approved by MARUTI as standard or optional equipment for your vehicle.
- Replacing the wheels and tyres equipped on your vehicle with certain combinations of aftermarket wheels and tyres can significantly change the steering and handling characteristics of your vehicle.
- Therefore, use only those wheel and tyre combinations approved by MARUTI as standard or optional equipment for your vehicle.

## ⚠ WARNING

(185/70R14 Tyre Fitted Vehicle)

The spare tyre, 165/80R14, and wheel are intended for temporary emergency use only. Continuous use of this spare can result in tyre failure and loss of control. Always observe these precautions when using this spare:

- Your vehicle will handle differently with this temporary spare.
- Do not exceed 80 km/h (50 mph) speed.
- Do not use tyre chains on the spare tyre. If you must use tyre chains, rearrange the wheels so standard tyres and wheels are fitted to the front axle.
- Replace the tyre as soon as the tread wear indicator appears.
- When replacing the spare tyre, use a replacement tyre with the exact same size and construction.

## Tubeless Tyres (If equipped)

Your vehicle is equipped with Tubeless Tyres. In tubeless tyre, a thin layer of butyl rubber is used for lining the inside of the tubeless tyre. This layer is to prevent air loss and fulfilling the purpose of tube. The air pressure is maintained by the sealing between tyre bead and wheel rim. Tubeless tyres are having advantage of slow air loss

and preventing sudden deflation while driving.

## Care and maintenance tips for tubeless tyres

1. Always maintain recommended inflation pressure. Driving continuously at low inflation pressure can lead to tyre damage.
2. In case any leakage is found, check for any nail penetration/valve core damage or rim bent. Damaged wheel must not be used.
3. In case tyre has run at low pressure, it must be inspected for any defect.
4. Whenever new tyre is fitted, always replace the valve.
5. If continuous high speed driving is required, increase tyre pressure by 5 psi over recommended inflation pressure.
6. Never run the tyre beyond TWI (Tread wear indicator). The tyre is recommended to be replaced when the remaining tread has worn to this point. The indicators are spaced across the tread around the tyre marked by a triangular symbol (TWI).
7. Always prefer tubeless tyre mounting machine. In case of manual mounting tyre/wheel rim damage may occur.
8. In case of any problem, please get in touch with MARUTI authorised dealer.

## Full Wheel Cover (If equipped)

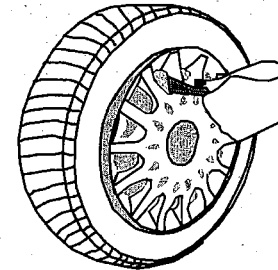

Insert a piece of cloth between the spokes of the wheel cover and try to pull the cover outward (as shown in figure).

Take out the detached wheel cover from the wheel rim.

For installation first match the slot at the wheel cover with the air filling nozzle of the wheel. Apply equal pressure at the circumference of the wheel cover to fix it in the wheel rim.

**Fuses in the Engine Compartment**

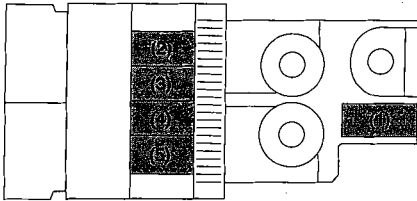

62J085

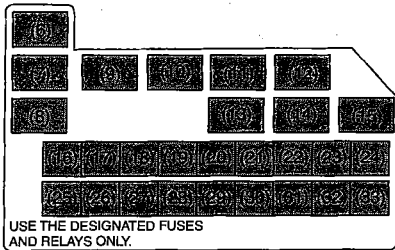

62J086

MAIN FUSE/PRIMARY FUSE		
(1)	80A	All electric load
(2)	50A	Power window, Ignition, Wiper, Starter
(3)	50A	Tail light, Rear defogger, Door lock, Hazard/Horn, Dome
(4)	80A	Heater, Air compressor, Power steering
(5)	80A	Radiator fan, Front fog light, Head light
(6)	-	Radiator fan relay #1
(7)	-	Radiator fan relay #2
(8)	-	Radiator fan relay #3
(9)	-	Starting motor relay
(10)	-	Main relay
(11)	-	Blank
(12)	-	Front fog light relay
(13)	-	Fuel pump relay
(14)	-	Air compressor relay
(15)	-	Blank
(16)	30A	Heater fuse
(17)	15A	FI fuse
(18)	10A	Air compressor fuse
(19)	-	Blank
(20)	15A	Brake light switch fuse
(21)	30A	ABS control module fuse

(22)	30A	Starting motor fuse
(23)	-	Blank
(24)	50A	Power steering control module fuse
(25)	30A	Ignition switch fuse
(26)	30A	Radiator fan fuse
(27)	-	Blank
(28)	30A	ABS control module fuse
(29)	-	Blank
(30)	-	Blank
(31)	15A	Front fog light fuse
(32)	15A	Headlight (Left) fuse
(33)	15A	Headlight (Right) fuse

The main fuse, primary fuses and some of the individual fuses are located in the engine compartment. If the main fuse blows, no electrical component will function. If a primary fuse blows, no electrical component in the corresponding load group will function.

To remove a fuse, use the fuse puller provided in the fuse box. The amperage of each fuse is shown in the back of the fuse box cover.

The fuse box is located under the driver's side of the dashboard. Remove the fuse box cover by pushing in at both ends and pulling off the cover.

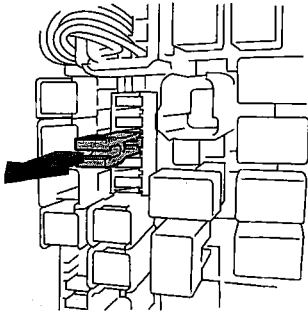

63J095

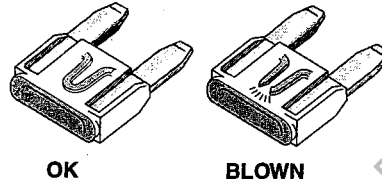

65D046

### ⚠ WARNING

Always be sure to replace a blown fuse with a fuse of the correct amperage. Never use a substitute such as aluminum foil or wire to replace a blown fuse. If you replace a fuse and the new one blows in a short period of time, you may have a major electrical problem. Have your vehicle inspected immediately by your MARUTI dealer.

## Bulb Replacement

### ⚠ WARNING

- Light bulbs can be hot enough to burn your finger right after being turned off. This is true especially for halogen headlight bulbs. Replace the bulbs after they become cool enough.
- The headlight bulbs are filled with pressurized halogen gas. They can burst and injure you if they are hit or dropped. Handle them carefully.

### CAUTION

The oils from your skin may cause a halogen bulb to overheat and burst when the lights are on. Grasp a new bulb with a clean cloth.

### CAUTION

Frequent replacement of a bulb indicates the need for an inspection of the electrical system. This should be carried out by your MARUTI dealer.

## Other General Lights

### Bulb holder

#### EXAMPLE

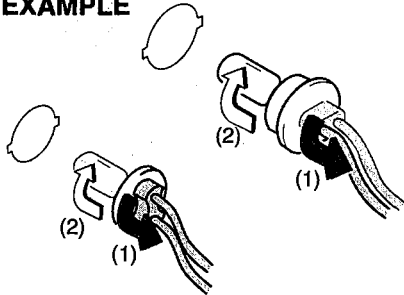

- (1) Removal
- (2) Installation

To remove a bulb holder from a light housing, turn the holder counterclockwise and pull it out. To install the holder, push the holder in and turn it clockwise.

54G123

### Bulb

#### EXAMPLE

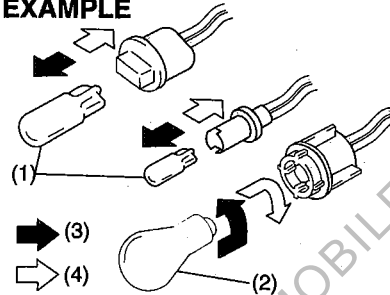

- (3) Removal
- (4) Installation

There are two types of bulb, "Full glass type" (1) and "Glass/metal type" (2).

To remove and install a full glass type bulb (1), simply pull out or push in the bulb.

To remove a glass metal type bulb (2) from a bulb holder, push in the bulb and turn it counterclockwise. To install a new bulb, push it in and turn it clockwise.

You can access the individual bulb or bulb holders as follows.

54G124

### Front parking light (1) Front turn signal light (2)

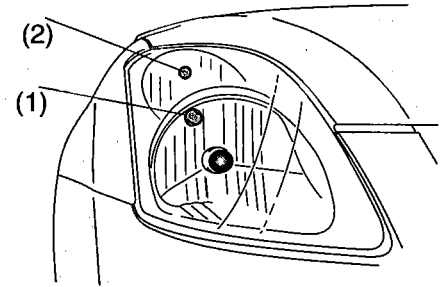

63J097

### Rear combination light

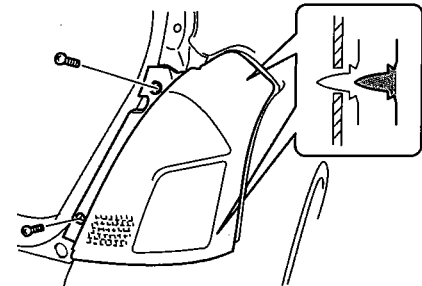

63J098

## Wiper Blades

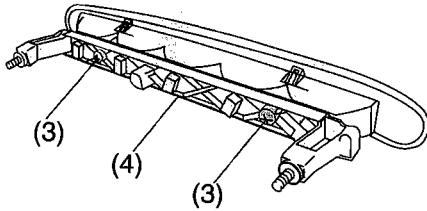

75J027

- 3) Loosen the two screws (3) as shown in the illustration and remove the bulb holder (4).
- 4) Replace the bulbs.  
To install a high-mounted stop light housing in the reverse order of removal.

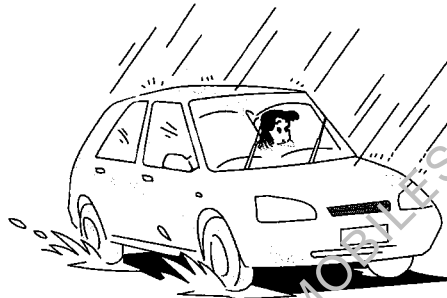

54G129

If the wiper blades become brittle or damaged, or make streaks when wiping, replace the wiper blades.

To install new wiper blades, follow the procedures below.

### CAUTION

To avoid scratching or breaking the window, do not let the wiper arm strike the window while replacing the wiper blade.

#### NOTE:

Some wiper blades may be different from the ones described here depending on vehicle specifications. If so, consult your MARUTI dealer for proper replacement method.

For windscreen wipers:

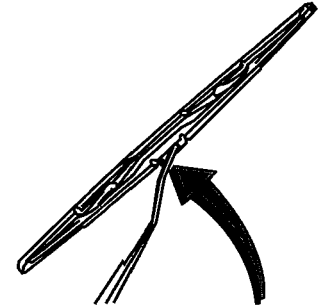

70G119

- 1) Hold the wiper arm away from the window.

For rear wipers:

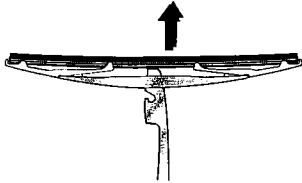
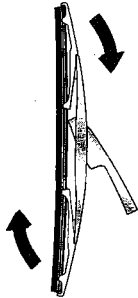

80G146

- 1) Hold the wiper arm away from the window.
- 2) Remove the wiper frame from the arm as shown.
- 3) Slide the blade out as shown.

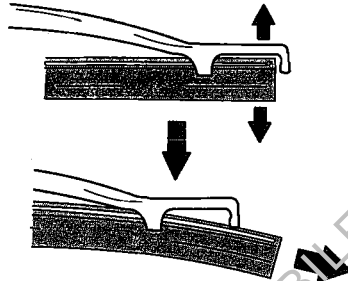

85D151

**NOTE:**  
Do not flex the wiper blade frame end more than necessary. If you do, it can break off.

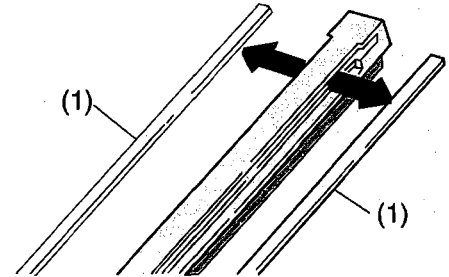

54G135

(1) Retainer

- 4) If the new blade is provided without the two metal retainers, move them from the old blade to the new one.
- 5) Install the new blade in the reverse order of removal.  
Make sure the blade is properly retained by all the hooks.
- 6) Reinstall wiper frame to arm in the reverse order of removal.

## EMERGENCY SERVICE

Jacking Instructions .....	9-1
Jump Starting Instructions .....	9-2
Towing .....	9-4
If the Starter Does Not Operate .....	9-4
If the Engine is Flooded .....	9-5
If the Engine Overheats .....	9-5

SAGAR AUTOMOBILES

## Towing

If you need to have your vehicle towed, contact a professional service. Your dealer can provide you with detailed towing instructions.

### CAUTION

**To help avoid damage to your vehicle during towing, proper equipment and towing procedures must be used.**

Manual transmission vehicles may be towed using either of the following methods.

- 1) From the front, with the front wheels lifted and the rear wheels on the ground. Before towing, make sure that the parking brake is released.
- 2) From the rear, with the rear wheels lifted and the front wheels on the ground, provided the steering and drivetrain are in operational condition. Before towing, make sure that transmission is in neutral, the steering wheel is unlocked (the ignition key should be in the "ACC" position), and the steering wheel is secured with a clamping device designed for towing service.

### CAUTION

**The steering column is not strong enough to withstand shocks transmitted from the front wheels during towing. Always unlock the steering wheel before towing.**

## If the Starter Does Not Operate

- 1) Try turning the ignition switch to the "START" position with the headlights turned on to determine the battery condition. If the headlights go excessively dim or go off, it usually means that either the battery is flat or the battery terminal contact is poor. Recharge the battery or correct battery terminal contact as necessary.
- 2) If the headlights remain bright, check the fuses. If the reason for failure of the starter is not obvious, there may be a major electrical problem. Have the vehicle inspected by your authorized MARUTI dealer.

SAGAR AUTOMOBILES

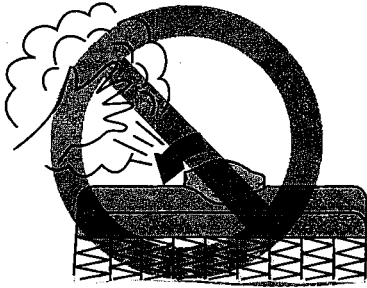

65D350

**▲ WARNING**

- It is hazardous to remove the radiator cap when the water temperature is high, because scalding fluid and steam may be blown out under pressure. The cap should only be taken off when the coolant temperature has lowered.
- To help prevent personal injury, keep hands, tools and clothing away from the engine cooling fan and air-conditioner fan (if equipped). These electric fans can automatically turn on without warning.

SAGAR AUTOMOBILES

## BODY WORK CARE

Corrosion Prevention .....	10-1
Vehicle Cleaning .....	10-2

SAGAR AUTOMOBILES

**Store your vehicle in a dry, well-ventilated area**

Do not park your vehicle in a damp, poorly ventilated area. If you often wash your vehicle in the garage or if you frequently drive it in when wet, your garage may be damp. The high humidity in the garage may cause or accelerate corrosion. A wet vehicle may corrode even in a heated garage if the ventilation is poor.

**⚠ WARNING**

**Do not apply additional undercoating or rust preventive coating on or around exhaust system components such as the catalytic converter, exhaust pipes, etc. A fire could be started if the undercoating substance becomes overheated.**

**Vehicle Cleaning**



76G044S

**⚠ WARNING**

**When cleaning the interior or exterior of the vehicle, NEVER USE flammable solvents such as lacquer thinners, petrol, benzene or cleaning materials such as bleaches or strong household detergents. The materials could cause personal injury or damage to the vehicle.**

**Cleaning the Interior**

**Vinyl upholstery**

Prepare a solution of soap or mild detergent mixed with warm water. Apply the solution to the vinyl with a sponge or soft cloth and let it soak for a few minutes to loosen dirt.

Rub the surface with a clean, damp cloth to remove dirt and the soap solution. If some dirt still remains on the surface, repeat this procedure.

**Fabric upholstery**

Remove loose dirt with a vacuum cleaner. Using a mild soap solution, rub stained areas with a clean damp cloth. To remove soap, rub the areas again with a cloth dampened with water. Repeat this until the stain is removed, or use a commercial fabric cleaner for tougher stains. If you use a fabric cleaner, carefully follow the manufacturer's instructions and precautions.

**Seat belts**

Clean seat belts with a mild soap and water. Do not use bleach or dye on the belts. They may weaken the fabric in the belts.

**Vinyl floor mats**

Ordinary dirt can be removed from vinyl with water or mild soap. Use a brush to help loosen dirt. After the dirt is loosened, rinse the mat thoroughly with water and dry it in the shade.

sponge or soft cloth. The sponge or cloth should be frequently soaked in the soap solution.

**CAUTION**

**When using a commercial car wash product, observe the cautions specified by the manufacturer. Never use strong household detergents or soaps.**

- 4) Once the dirt has been completely removed, rinse off the detergent with running water.
- 5) After rinsing, wipe off the vehicle body with a wet chamois or cloth and allow it to dry in the shade.
- 6) Check carefully for damage to painted surfaces. If there is any damage, "touch-up" the damage following the procedure below:
  1. Clean all damaged spots and allow them to dry.
  2. Stir the paint and "touch-up" the damaged spots lightly using a small brush.
  3. Allow the paint to dry completely.

**CAUTION**

**If you use an automatic car wash, make sure that your vehicle's body parts, such as spoilers, can not be damaged. If you are in doubt, consult the car wash operator for advice.**

**Waxing**

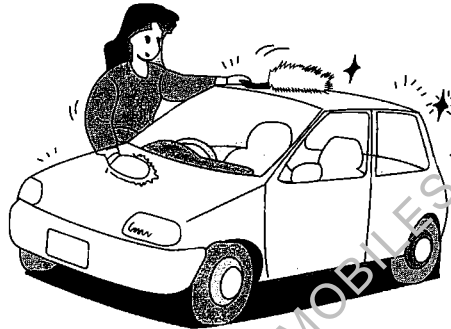

60B211S

After washing the vehicle, waxing and polishing are recommended to further protect and beautify the paint.

- Only use waxes and polishes of good quality.
- When using waxes and polishes, observe the precautions specified by the manufacturers.



[HOME](#)